

TRUS LIFT™ 750 - Commercial

Businesses - Churches - Community Centers - Public Buildings



An Affordable Accessibility Option for Commercial Buildings

Overview and Specifications

Standard Specifications

- Constant Pressure Operations
- 750lb capacity
- 8 ft/min travel speed
- Direct Geared Belt Drive Technology—no slippage and reliable lifting capacity
- Non-Load bearing back up safety nut
- Non-skid platform surface
- 110VAC, 1 Phase, 15A, Dedicated circuit
- UL/ CSA Certified
- Travel Models: 28in, 52in, 72in, 96in, 120in, 144in, 168in
- Levels Service 2 (standard) or 3
- Powder Coated Steel Finishes
- Emergency Stop Button
- Keyed lock out standard



Canadian, Unenclosed, Commercial Lift

RAM's commercial vertical platform lift is built on a double nut screw drive arrangement that is purely electro-mechanical and avoids machine rooms and hydraulics.

RAM has been perfecting the screw drive system for over 30 years and is one of the most economical and reliable lift systems available.

With models that range as small as 28in of travel all the way up to 14ft of travel RAM can cater to a wide variety of commercial building applications with the Trus-T-Lift™ product.

Lifts become more economical than ramps for applications where the rise is over 2 ft and in cases where there simply is not enough space to accommodate the 12:1 ratio for the grade on ramps (12in of run for 1in of rise).

Entry-Exit Styles

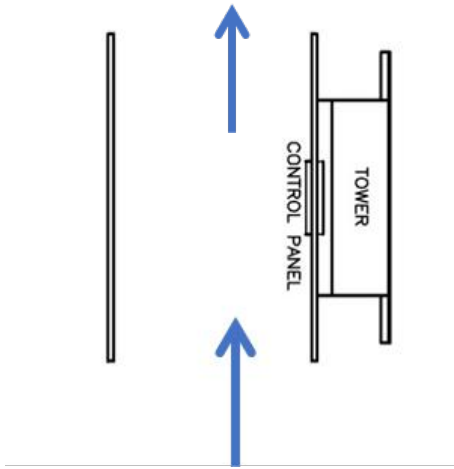

Straight Through

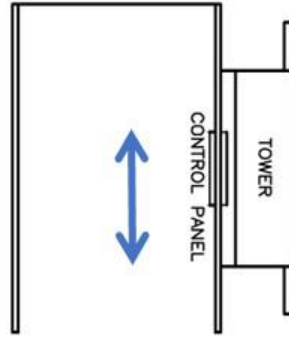

In-Out Same Side

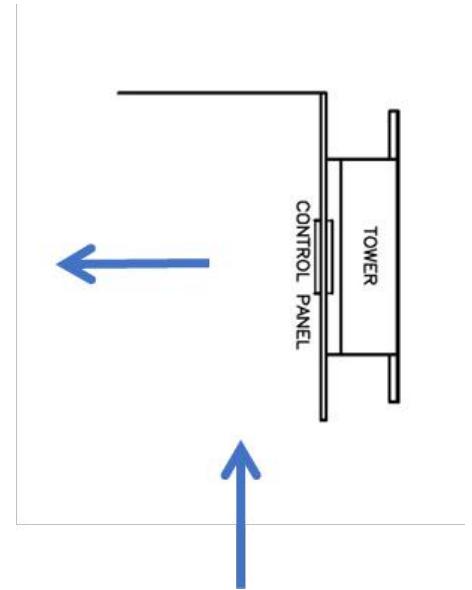

Adjacent/ 90 Deg

(turn can be either right or left hand)

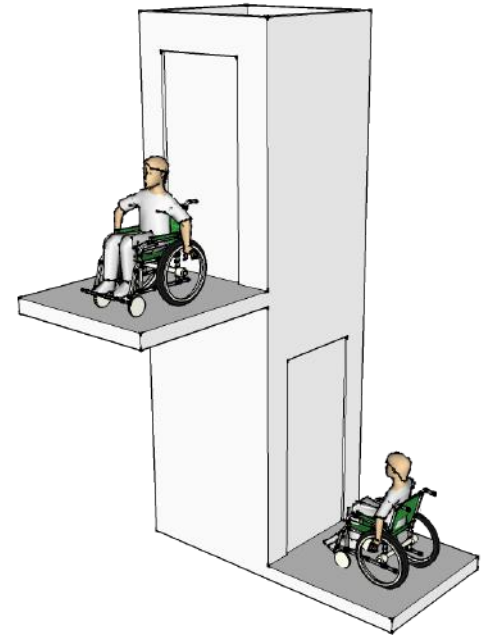
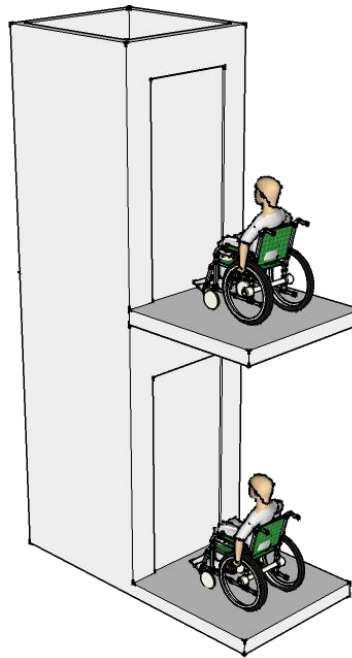
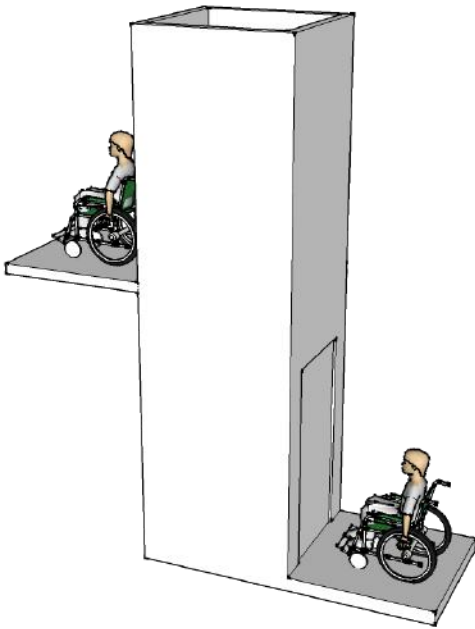

Although virtually any size of travel can be used in either of the straight through or adjacent style lift configurations, **realistically, only lifts that are 96in or above can be used for the in-out same side configuration.**

This is because the overhead height of a human being can't really be accommodated with anything less than this amount of travel.

In many cases, the in-out same side and adjacent style lifts require auto-operators on the doors or gates to allow for effective use by people with mobility issues.

Physical Size

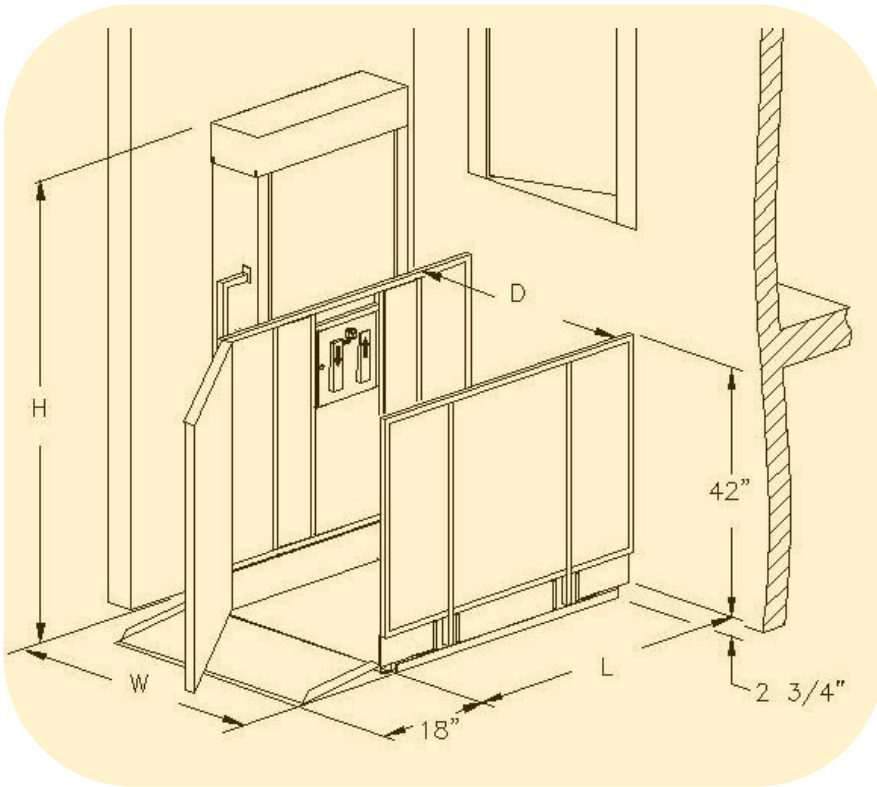

Straight Through or In-Out Configuration

L = Deck Length = 54 in (1371mm)¹

D = Deck Width = 34in (864mm)²

W = Total Width = 49in (1245mm)

Travel Height	Tower Height (H)
28in (711mm) Max	61.5in (1562mm)
52in (1321mm) Max	85.5in (2172mm)
72in (1829mm) Max	105.5in (2679mm)
96in (2438mm) Max	131.5in (3340mm)
120in (3048mm) Max	155.5in (3949mm)
144in (3658mm) Max	179.5in (4559mm)
168in (4267mm) Max	203.5in (5168mm)

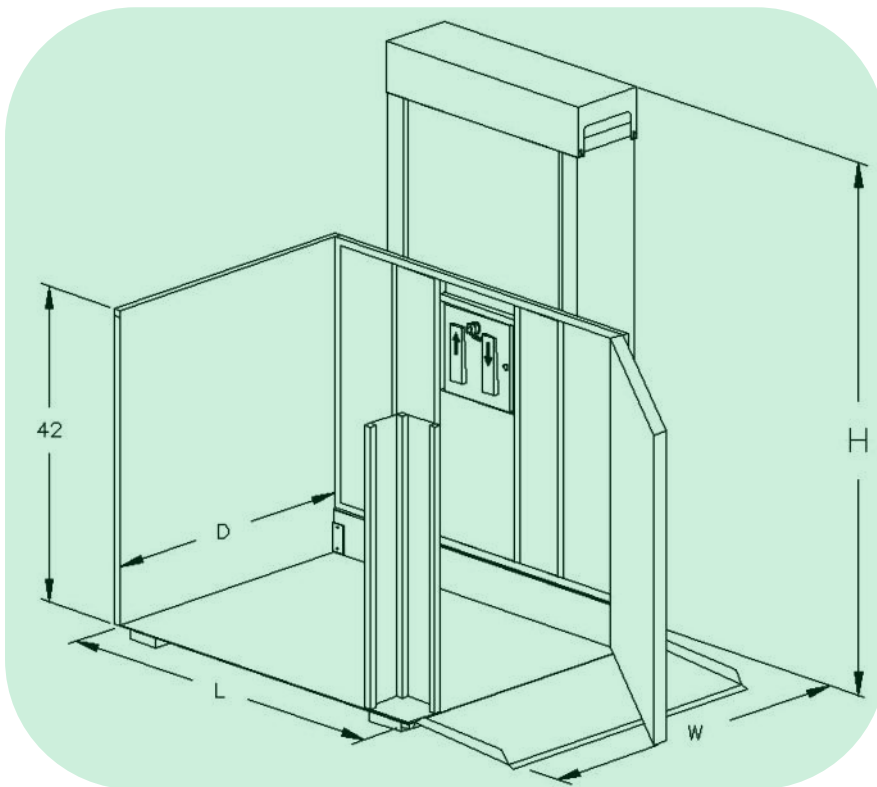

Adjacent/ 90 Degree Turn Configuration

L = Deck Length = 54 in (1371mm)

D = Deck Width = 40in (1016mm)³

W = Total Width = 54in (1371mm)

See RAM's official installation drawing for specific details on site preparation and installation.

1. Custom lengths can be provided up to 60in in length
2. Some local codes require 36in wide platforms
3. Some local codes require 42in wide on adjacent lifts

Doors, Gates and Auto-Operators

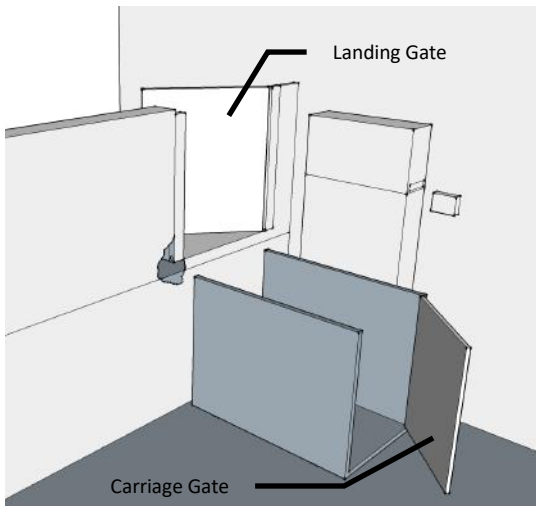

Landing Gate - the landing gate is typically 42in high for commercial applications and is equipped with an interlock that will prevent the gate from being opened if the platform is not in the full up position. This avoids a user walking or rolling in to empty space by accident.

Carriage Gate - this gate will travel with the platform as it moves up and down and is a key safety feature on taller lifts that are unenclosed. Typically 42in high for commercial applications.

RAM Full Height Door - full height doors are required on the lower level when a lift is required to be placed in a full shaft way. RAM's full height door is powder coated steel and incorporates interlocks and call buttons for easy installation and a professional finish.

Fire Rated Door (1.5hr) - in some cases a fire rated shaft and door is required and RAM can provide this option on request. If you are not sure then using a fire rated door is recommended in commercial applications.

Glass Doors - glass can be a very attractive architectural finish and RAM can offer glass inserts in our non-fire rated doors as an option. In some cases we can also provide interlocks only that can then be mounted to glass doors provided by others but local regulatory agencies should be consulted in advance and mounting details should be confirmed prior to order placement.

Flush Door or Gate

In order to meet safety codes flush doors or gates are required on accessibility lifts. This is primarily to avoid shear edges that might cause injury or harm to a user as lift has open sides on the carriage platform. This reduces the cost of a lift in comparison to a commercial elevator in most cases. Most commercially available doors are not flush with the inside edge of the door jamb so buying the doors or gates from RAM is often your best option for commercial projects. RAM will also integrate safety interlocks and call buttons so they look clean and professional which reduces installation time substantially.

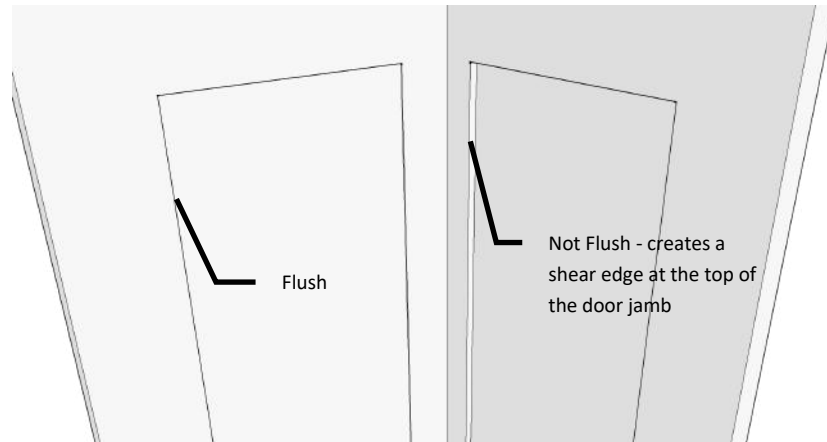
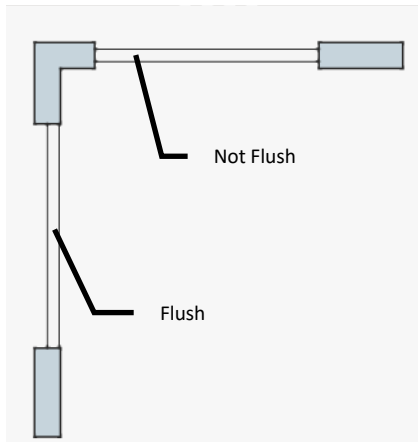

Auto-Operators

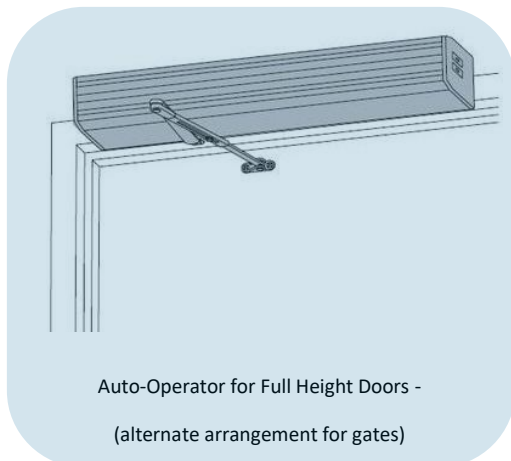

Gates and Doors come equipped with spring closing mechanisms as a standard but in some applications a powered auto-operator to open and close the gate or door may be required. Whether these options are required depends on the configuration and local authorities. A good rule of thumb is that all lifts with either the in-out same side or adjacent entry exit style should be equipped with auto-operators in commercial applications.

RAM has worked with virtually every product on the market to balance the cost vs. reliability and although the products RAM incorporates with our lifts are not the least expensive they are the best value in our opinion and they can be relied upon to function for many years.

Commercial Lift Application 1 - Unenclosed Straight Through

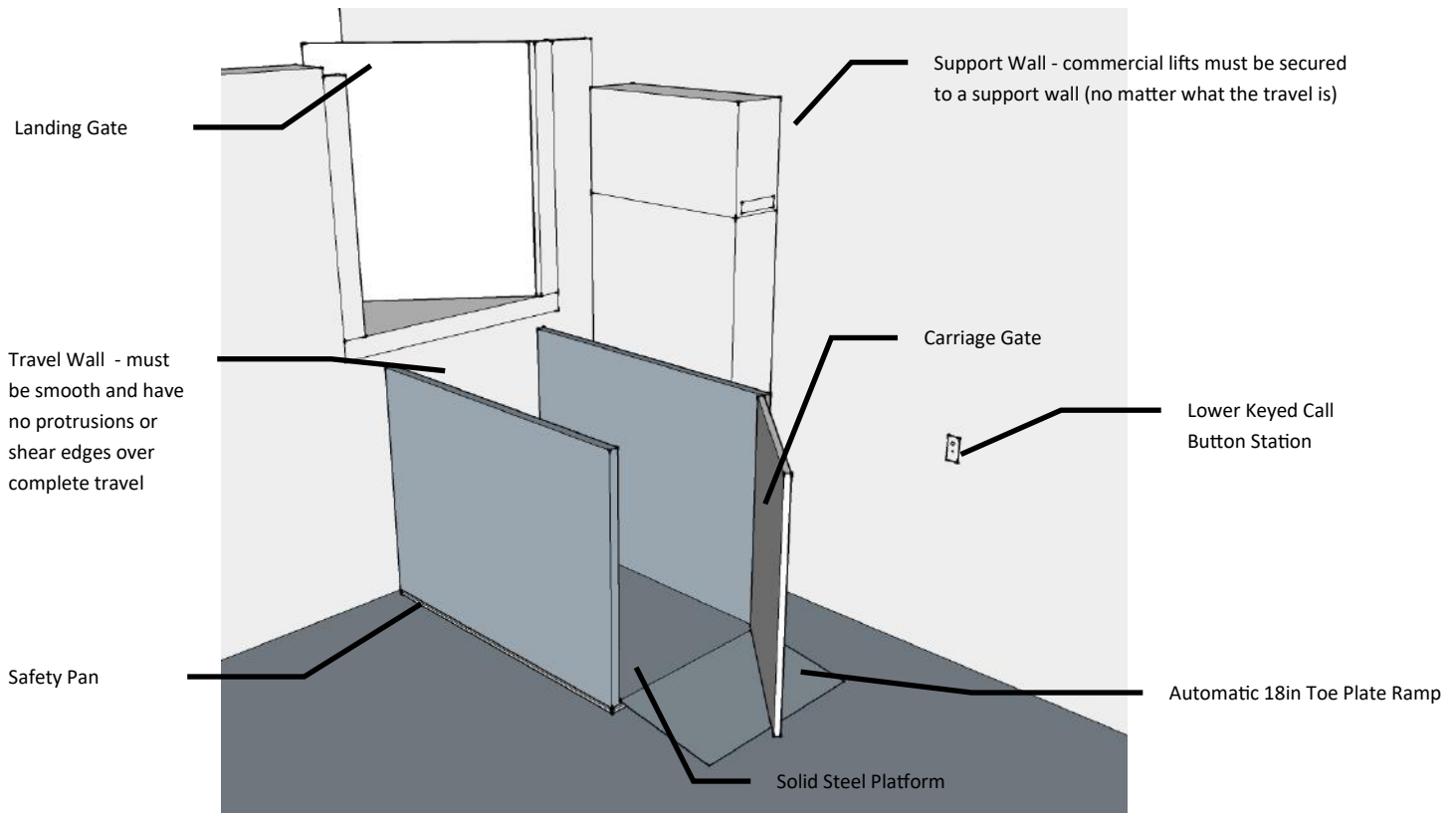

Unenclosed lifts are allowed under both Canadian and US safety codes (CSA B355 and ASME A18.1) but they differ in the maximum travel they will allow before a lift must then be placed in a full shaft way. **For Canada and the US the limits are 98in and 60in of travel respectively.**

At the same time, both codes allow local authorities to add requirements and **in some jurisdictions all commercial lifts, regardless of travel height are required to be placed in full shaft ways** (for example BC and Ontario). Check with local authorities during planning and design stages to confirm any local requirements and avoid surprises.

Required Options

- Solid platform
- Safety Pan to avoid trapped objects underneath platform
- 18in toe plate ramp
- Emergency Light and Bell Package
- UPS - to ensure doors or gates can be opened in case of power failure
- Keyed Call Buttons at both landings
- Upper landing gate with interlock
- Carriage Gate with interlock (optional in some Canadian Jurisdictions)

Alternative Options

- Upper Landing Door
- Upper landing Interlock - for customer supplied door or gate
- 2in pit instead of 18in toe plate ramp
- Full Tower of Power DC Back Up System (30 full travel cycles)
- Upgrade to call/send toggles at each landing
- Extended size/ custom platform (60in x 40in max)
- Auto-operators on gates or doors
- One touch, two-way comms device
- Special keys (i.e. Chicago key) to meet local requirements

Commercial Lift Application 2 - Enclosed, In-Out Same Side

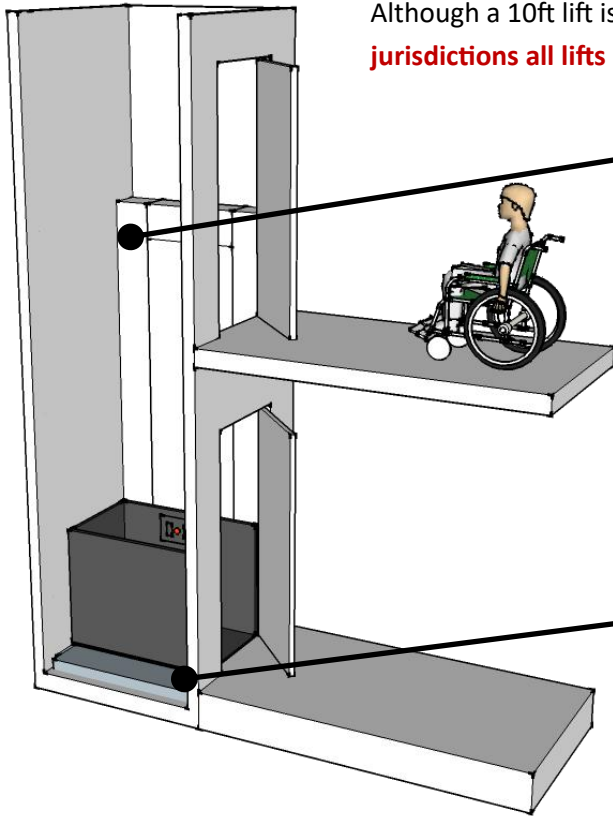

Although a 10ft lift is shown here smaller lift can certainly be place in shaft ways. **In some jurisdictions all lifts must be placed in fully enclosed shaft ways.**

In some jurisdictions “shrouds” on either side of the tower are required. RAM can provide these as an option but generally needs to know the specific shaft dimensions. Shrouds avoid debris being left in the shaft and provide a clean appearance as well.

2in pit



Two-Way Communications Device

In some jurisdictions a one button communications device is required on board the platform instead of, or in addition to, an emergency bell and light. These devices can be added to any lift and they can then be programmed to dial a specific number. The shaft construction requires a phone line in order to function properly. **These are more common for enclosed lifts where a passenger is not visible.**

Required Options

- Solid platform
- Emergency Light and Bell Package
- UPS - to ensure doors or gates can be opened in case of power failure
- Keyed Call Buttons at both landings
- Upper landing gate with interlock or door (door shown above)
- Lower door with interlock

Alternative Options

- Upper/ lower landing safety Interlock - for customer supplied doors
- Exterior threshold ramp instead of pit
- Full Tower of Power DC Back Up System (30 full travel cycles)
- Upgrade to call/send toggles at each landing
- Extended size/ custom platform (60in x 40in max)
- Auto-operators on gates or doors
- One touch, two-way comms device
- Special keys (i.e. Chicago key) to meet local requirements
- Tower Side Shrouds

Commercial Lift Application 3 - Unenclosed 90 Degree Adjacent

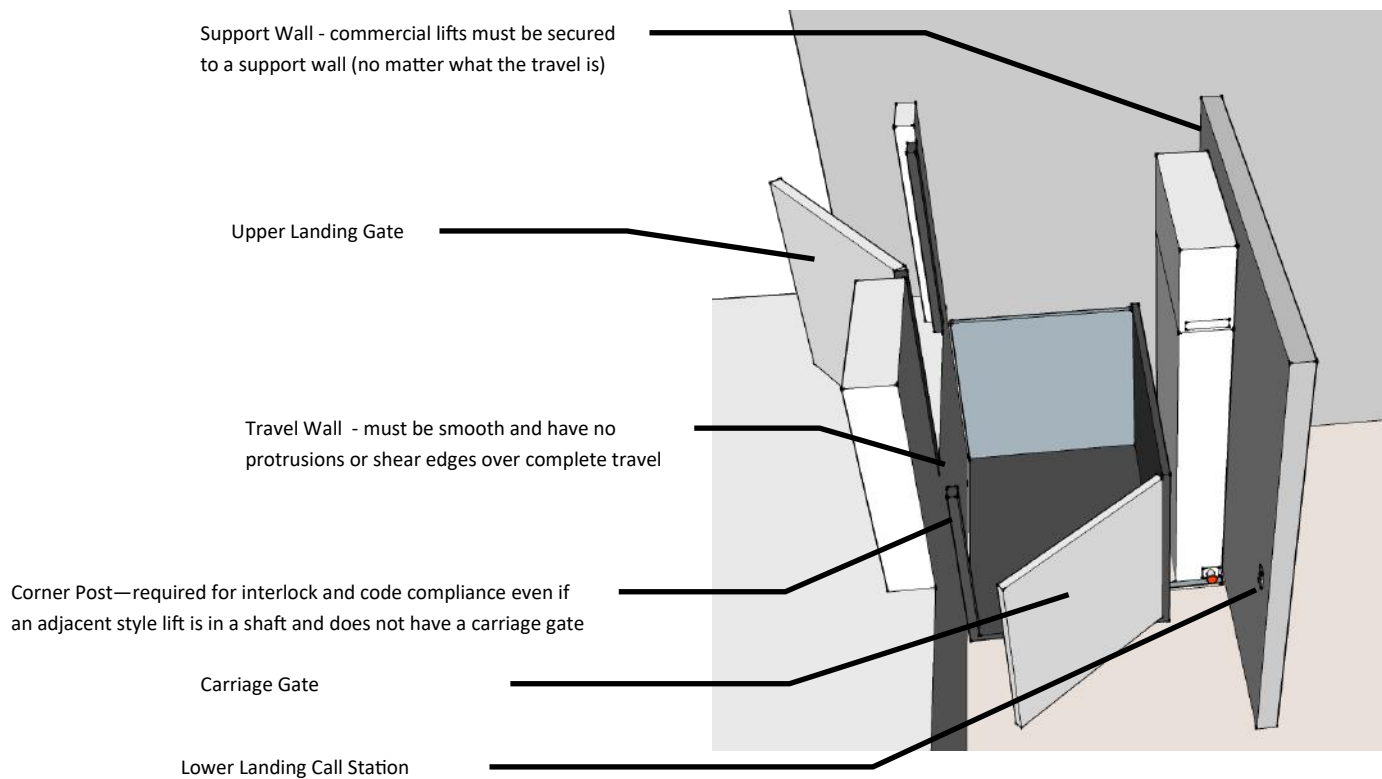

Unenclosed lifts are allowed under both Canadian and US safety codes (CSA B355 and ASME A18.1) but they differ in the maximum travel they will allow before a lift must then be placed in a full shaft way. **For Canada and the US the limits are 98in and 60in of travel respectively.**

At the same time, both codes allow local authorities to add requirements and **in some jurisdictions all commercial lifts, regardless of travel height are required to be placed in full shaft ways** (for example Ontario, Canada). Check with local authorities during planning and design stages to confirm any local requirements and avoid surprises.

Required Options

- Solid platform
- Safety Pan to avoid trapped objects underneath platform
- 18in toe plate ramp
- Emergency Light and Bell Package
- UPS - to ensure doors or gates can be opened in case of power failure
- Keyed Call Buttons at both landings
- Upper landing gate with interlock
- Carriage Gate with interlock (optional in some Canadian Jurisdictions)
- 40in wide platform

Alternative Options

- Upper Landing Door
- Upper landing Interlock - for customer supplied door
- 2in pit instead of 18in toe plate ramp
- Full Tower of Power DC Back Up System (30 full travel cycles)
- Upgrade to call/send toggles at each landing
- Extended size/ custom platform (60in long max)
- Auto-operators on gates or doors
- One touch, two-way comms device
- Special keys (i.e. Chicago key) to meet local requirements

Shaft Walls & Concrete Slab

Blocking at 17.5 in lower than Tower Max Height

Return Wall to Edge of Door on Tower Side is Critical to avoid gaps at the doorway platform interface

Double 2x4 Studs

Many shafts are constructed from wood and drywall. RAM will provide a detailed shaft construction and installation drawing but there are a few areas that are critical to keep in mind during planning:

1. Return Wall distance to door jamb on tower wall 10.5in
2. Location and spacing of double 2x4 studs on tower placement wall
3. Blocking Height (A) for where the tower will attach to the wall. Height (A) is 6.5in lower than the maximum height of a tower. So, for a 120in lift, the top of the tower is 144.5in so the center of the blocking should be at 138in from where the tower will rest (i.e. pit floor)

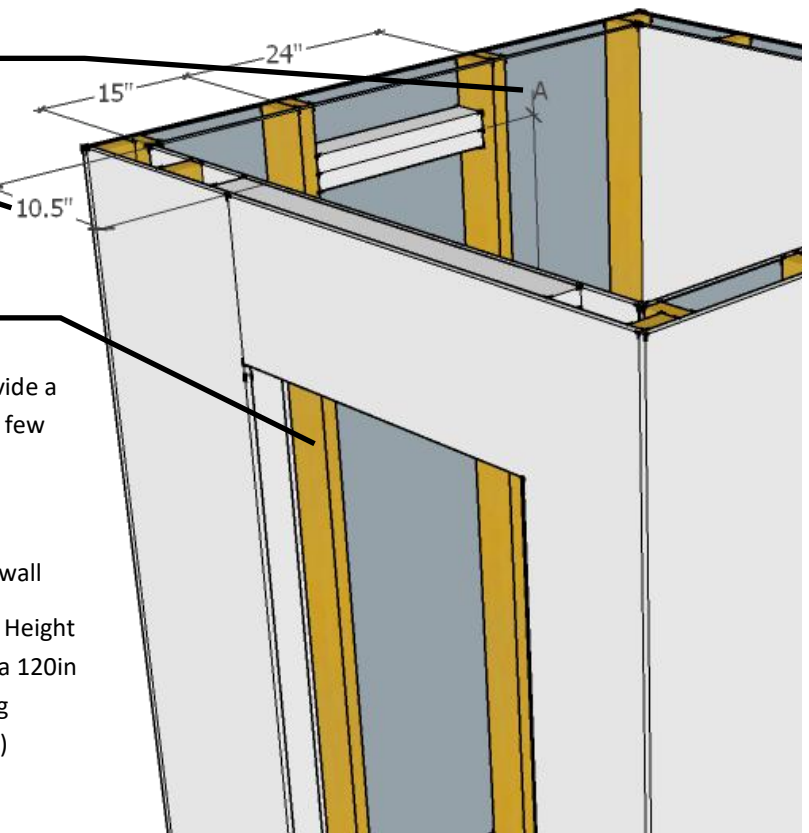

Concrete Filled Block Wall where tower will attach to the support wall

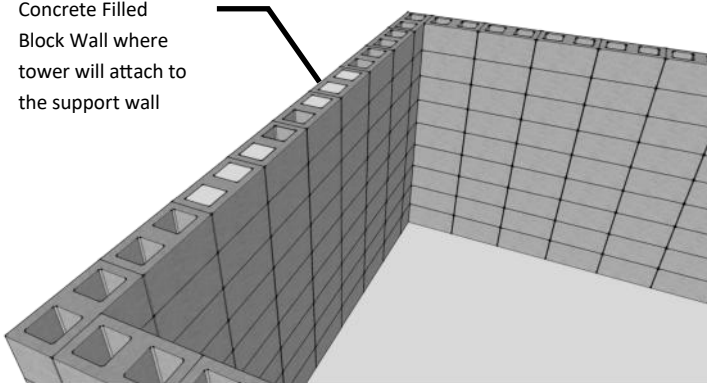

In some cases a “block wall” is constructed to contain the lift. In these cases the contractor should ensure that the blocks where the tower will be secured are filled (either with concrete or epoxy). If they are not then you will need to either construct a false wood wall, which could impact the space available, or you can put rod anchors all the way through the block wall with large washers and nuts on the other side. In many cases going through the blocks is not feasible as it will leave exposed snag points or go through to the exterior of a building. Block wall construction should be considered carefully for this reason and for electrical/ control wiring runs.

Concrete Slab Detail

For unenclosed lifts a 5ft x 5ft pad for the lift is sufficient but a turning radius of 5ft x 5ft outside the lift is typically required as well.

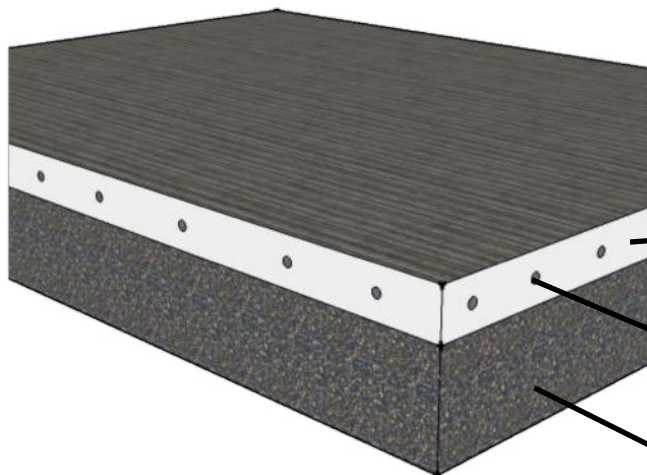

4 - 6in thick concrete 4500 psi (30MPa) min

1/2in diameter rebar @ 12in on center and 2in from top of concrete

8-10 compaction rock

Reaction Load & Shaft Fit Guidelines

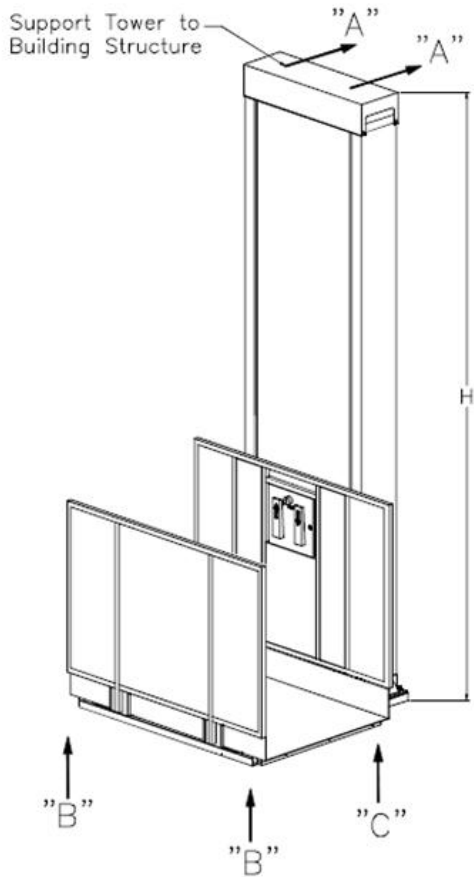

REACTION LOADS ON BUILDING

TTL 750 MAX. REACTION LOADS (LBS)

TOWER TRAVEL	HORIZONTAL LOAD (A)x2	VERTICAL LOAD (B)x2	VERTICAL LOAD (C)x2
28	260	336	274
52	172	336	299
72	134	336	319
96	106	336	344
120	88	336	369
144	75	336	394
168	65	336	419

Shaft Fit/ Installation

Trus-T-Lift™ Towers are shipped pre-assembled in one piece. This can cause issues with some of the larger travel lifts during installation if there is not sufficient room to get the tower tilted in to the shaft. 14ft towers typically need to be inserted prior to final close up of a shaft or have a taller door way rough in to ensure efficient access. If the tower is installed prior to final shaft close up, care should be taken to cover the lift during any final drywall/ taping/ sanding activities. The lift may also require cleaning and re-greasing prior to commissioning and hand over to the client.

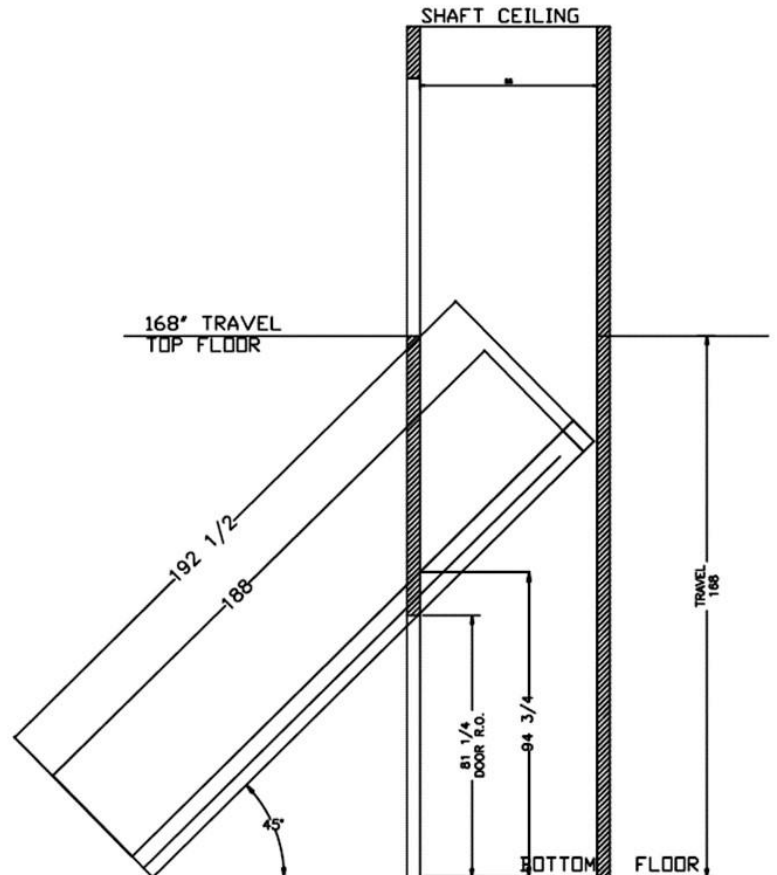
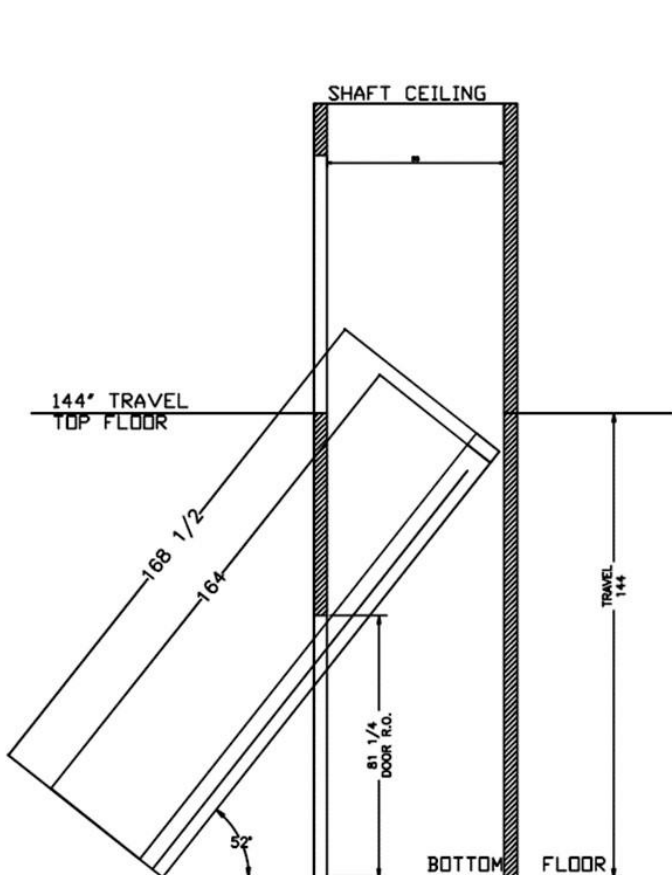

Commercial Lift Power, Controls, Disconnect Guidance

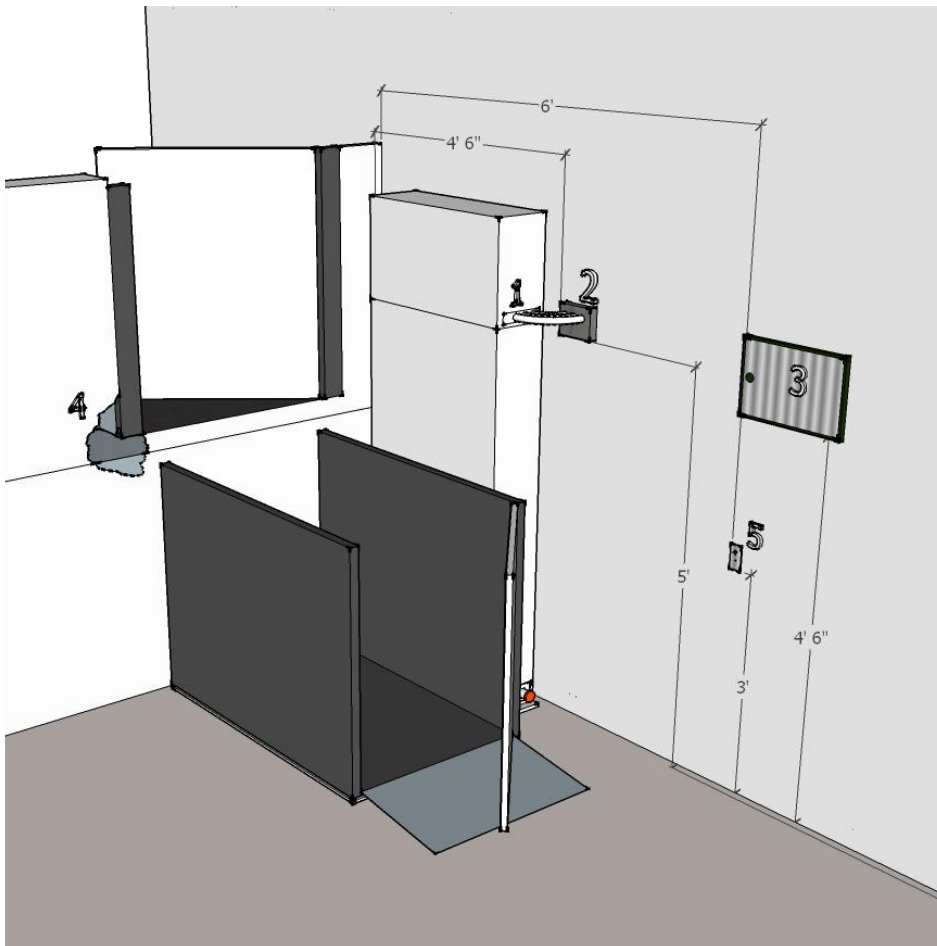

The electrical and controls for a lift can be done in several ways for a commercial lift.

- Run basic wiring provided by RAM through conduit on exterior or walls
- Request flex cable from RAM as an optional upgrade and run the cable along walls
- Request Teck cable from RAM as an upgrade and run the cable along walls

A key part of a commercial installation is the disconnects, which must both be lockable in the “off” position and fused as per electrical code requirements. An electrician must supply and install both disconnects for both main power and the UPS (uninterruptable power supply) that is required for the emergency light and bell as well as the interlocks. Both disconnects shall be 15A, 110VAC rate and final tie in shall be done by an electrician prior to inspection. **RAM does not supply disconnects.**

In some jurisdictions, a pit switch is also required. If you require a pit switch please advise RAM of this requirement in advance.

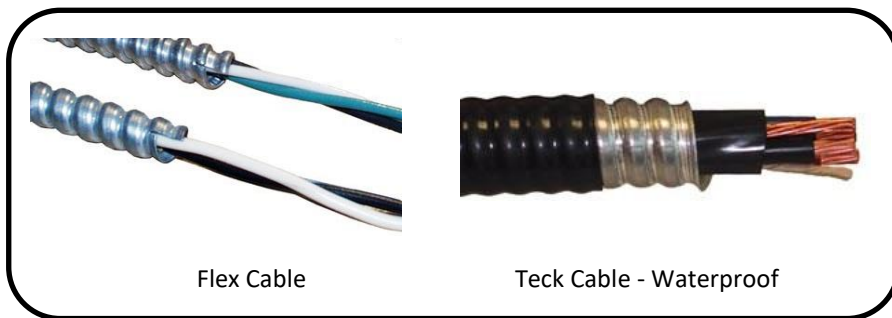

Flex Cable

Teck Cable - Waterproof

The cleanest appearance is to have electrical wiring roughed in to the structure of the building in advance of lift installation. This should be used in conjunction with RAM’s overall installation drawings.

An example of a rough-in is shown above with the following items and wiring:

Item 2: 4x4 junction box, Item 3: 6x10 flush cabinet with double disconnect switch, Item 5: 2x4 junction box for push button

Wiring rough-in requirements:

Rough in 3 conductor + Ground, 16ga, cable that is encased in flex from junction box (2) through the wall to allow connection with the lower landing push button call station (5)

Rough in 8 conductor + ground, 16ga, cable that is encased in flex from junction box (2) through the walls to position (4) to enable connection with the upper landing gate interlock and push button. An additional 4 conductors will be required if an auto-operator is required.

Rough in 2 x (2 conductor + Ground), 14ga, cable encased in flex from junction box (2) through to disconnect panel (3)

Commercial Lift Configuration Checklist

Client Contact Name	_____	State/ Province	_____
Address	_____	Zip/ Postal Code	_____
City	_____	Phone Number	_____
Email	_____		
Dealer Company Name	_____	Dealer Phone	_____
Dealer Contact Name	_____	Dealer Email	_____

Max Travel

- Less Than 28in Less Than 52in Less Than 60in Less Than 72in Less Than 96in
Less Than 120in Less Than 144in Less Than 168in

Entry Exit Style

- Straight Through 90 deg Adjacent In-Out Same Side

Tower Placement*

- Back Wall
Right Hand Side Left Hand Side

Upper Landing

- Landing Gate Full Height Door Interlock Only
Right Swing Left Swing Swing N/A
Fire Rated Door Auto-Operator Glass Door Insert

Installation Type

- Enclosed in Shaft Unenclosed

Access at Lower Landing

- Toe Plate Ramp Pit Exterior Ramp

Lower Landing

- Carriage Gate Full Height Door Interlock Only
Right Swing Left Swing Swing N/A
Fire Rated Door Auto-Operator Glass Door Insert

Special Options

- Tower Shrouds for Inside Shaft
Chicago Keys
Two Way Comms Device
Tower Shrouds for Inside Shaft
Full DC Power Back Up
Call/ Send Toggles
Custom Size Platform
Custom Size Door/ Gate

Additional Comments/ Requests

*Note that tower placement is based on facing the shaft or entrance of the lift at the lowest landing.

Vertical Platform Lifts are designed to meet ASME A18.1/ CSA B355 Safety Standards when properly equipped. While RAM VPL's meet national standards, it is imperative to check State/ Provincial standards as well as local code requirements before purchasing or installing to ensure code compliance. All State/ Provincial/ Local code compliance is the responsibility of the purchaser. Some states/ provinces may require fees for permits and inspection.